

The Visual Approach in Educational Projects

A.K. Dadykin

Belarusian National Technical University, Languages Studio, Belarusian National Technical University
Minsk, Belarus

V.A. Dibrova

Kiev, Ukraine

I.H. Tahini

Beirut, Lebanon

Abstract—International complex projects in the field of education and training require the involvement of a number of experts from different countries, different branches of science and technology. Differences in terminology, methods and languages lead to significant difficulties in collaboration and mutual understanding. The main idea of the article is finding new ways to improve communication and mutual understanding, finding new ways of learning and teaching. The new results were obtained by using a visual approach and visual models and tools of systems analysis and information technologies. The text gives a detailed analysis of some basic scientific theories and provides visual models resulting from this analysis. These models formed the basis for the practical application of the visual approach for learning foreign languages for adult, and helped to create some computer applications, simulators and control systems of the learning process. The proposed visual approach to the display of the structure of scientific theories, a study of the general laws, previously hidden behind the words and terminology, and the application of these laws in the education and training systems is of considerable interest. The practical application of this approach in the experimental groups of adult learners showed very encouraging results and the prospect of further research and development in this direction.

Index Terms—Activity Matrix, Activity structure, Visual approach, Visual Model, Visualization.

I. INTRODUCTION

The Information Technology revolution has changed the way we live, work and learn. It has increased the importance of education, training and lifelong learning. They have changed their systems and organization.

All this requires a serious research and development with the participation of specialists in the different fields of science, technology and practice.

As in all spheres of human activity, scientific and technical terms are based on the terminology that is based on the words of natural languages, it leads to the differences in the understanding of the meaning, scope, content, concepts and structure their interactions, depending on the application.

Structure of the language inevitably superimposed on the structure of any theoretical model, and the structure of the psyche of the subject who created this model too.

Therefore the visualization of terms and concepts of basic scientific theories and practical pedagogical models is a very interesting way to highlight the typical patterns on the highest level of structure and reduce the impact of this projections.

This article presents the results of using visual approach to certain psychological and educational theories for the purpose of expansion and improvement.

II. INVERSION OF THE STRUCTURAL DIFFERENTIAL

The Korzybski's structural differential [1] represents very important structure. It's interrelation between the events in reality, the representation of them in the psyche, and the designation of them using verbal labels.

This model allows you to control the levels of abstraction in the process of creating scientific models, and allows to avoid typical mistakes - false identification, objectification, elementalism.

But the structural differential contains within itself a contradiction between the physical placement of levels of abstraction and its usual language definition. Higher levels of abstraction is located at the bottom and less abstract is at the top.

To resolve this contradiction, we offer to draw a visual model of Structural Differential with the location of levels as in natural languages and in common models (Fig. 1). It means to turn levels upside down.

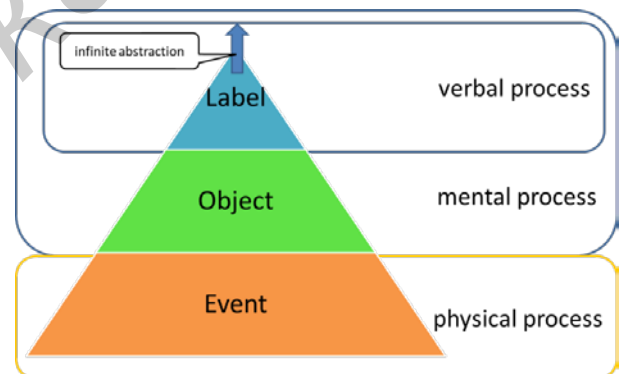

Fig. 1. Inversion of the Structural Differential.

Structural differential is the most important of the various models that is not fully realized. It is useful to examine other models via topological analysis according to the levels of abstraction. This approach is demonstrated in the following sections of this publication.

III. FUNCTIONAL MODEL OF THE MIND

There are many models of the brain, mind and psyche. All of them show some regularities and patterns, but most of them are overwhelmed by the details of the different levels of abstraction and therefore not very suitable for the topological and semantic analysis.

We offer structurally identical models for physiological brain structures (Fig. 2) and functional structures of the mind (Fig. 3) with a minimum number of elements.

This models, despite its simplicity, allow to perform logical

and topological transformation to many well-known pedagogical, psychological, and philosophical models and see similar structures in them. It is N. Burch's models of unconscious competence [2] (frequently attributed to A. Maslow), K. Jung's model of psychological types [3], A. Bandura's four-stage model of observational learning [4], P. Galperin's theory of stage-by-stage formation of mental actions [5], H. Gardner's model of multiple intelligences [6] and others.

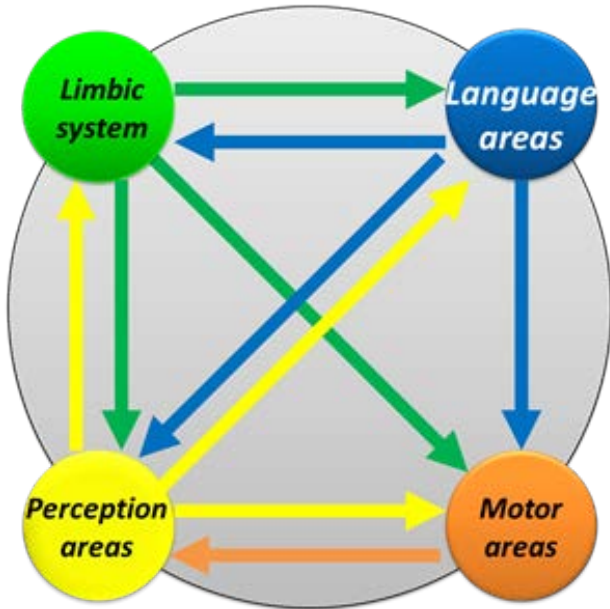

Fig. 2. Simple model of brain.

of teaching, masks the important didactic principle of presenting teaching matters visible and belittling the role of visual aids, visual thinking and other sensory mechanisms.

Therefore, if we add one more primary domain, sensation (perceptual) one, to the educational structure and taxonomy, it significantly expands the educational possibilities and opportunities (Fig. 4).

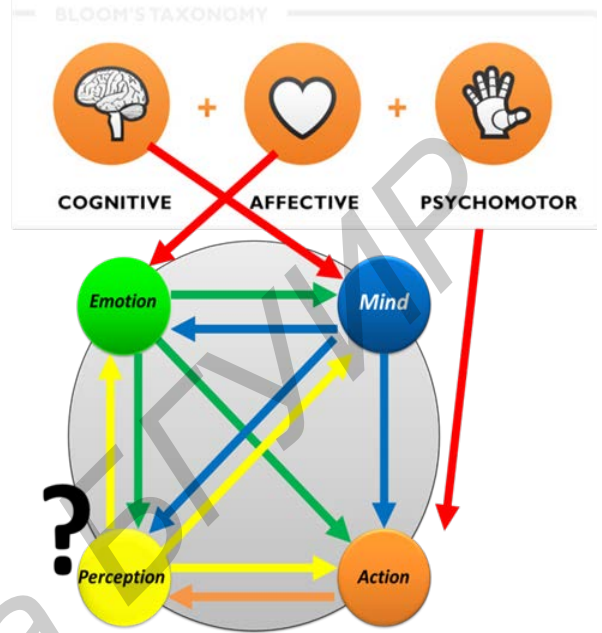

Fig. 4. Proposed extension of Bloom's domain.

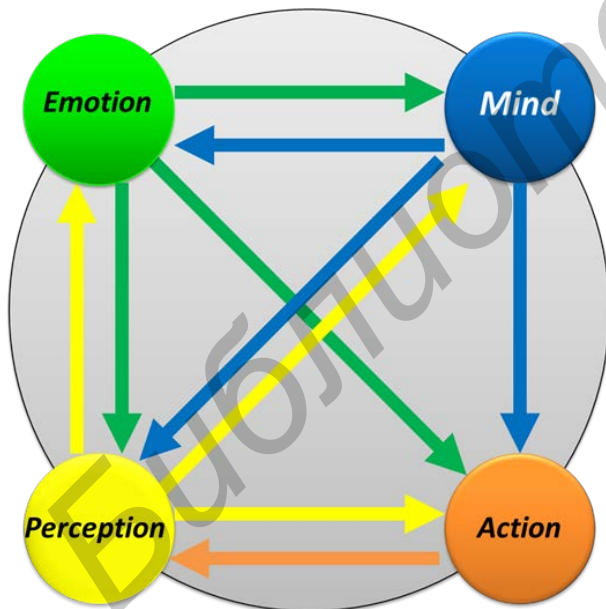

Fig. 3. Model of Mind/Psyche.

Unfortunately, we can't give here more details about all these structures and results obtained by using our visual approach. Here we focus on the B. Bloom's taxonomy [7] and its well-known model of three domains.

This model is widely used in education due to the good combination of simplicity and consistency. But, in some cases, the assignment of the sensor system to the psychomotor domain is not the best solution. This approach leads to mixing abstraction levels by A. Korzybski [1] and greatly limits ways

IV. MODEL AND MATRIX OF ACTIVITY

The visual approach was applied to another important psychological conception that was the A. Leont'ev's theory of activity [8]. It is a psychological and methodological basis of Eastern European countries educational systems. This theory is well developed and tested in practice, but little known in the West due to linguistic, terminological and ideological barriers.

To improve understanding of the Leontiev's theory of activity [8], we apply visual notation of IDEF0 [9] (Fig. 5) and place the terms of this theory, in accordance with the rules of this notation (Fig. 6).

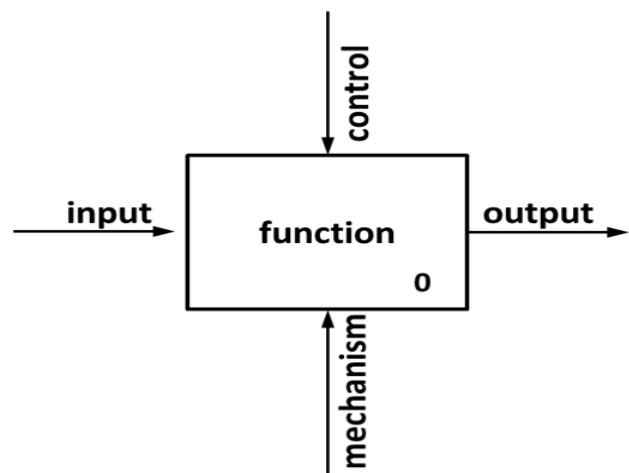

Fig. 5. IDEF0.

The next step of the analysis was evolving the elements of this model on levels of Korzybski's Structural Differential [1]. The result of transformation was a very interesting structure, that we named The Activity Matrix (Fig. 7).

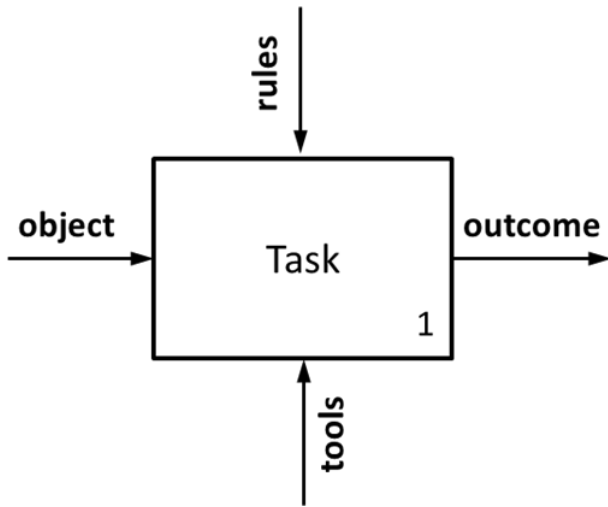

Fig. 6. Activity Model in Leont'ev's terms.

Reality	Mind	Language
process	skill	task
outcome	aim	objective
doer	subject	person
tool	competence (technique)	rules
thing	object	name
need	emotion	cause

Fig. 7. Activity Matrix.

It can be used to enhance the educational institutions with the best ideas and methods of pedagogy, and for accelerating the transformation of obsolete educational systems of the ex-Soviet countries to the European standards. Further development in this direction needs to connect a wide range of professionals to carefully harmonize terminology, structure and content on the languages of the concerned countries and within the specific subject fields, to avoid any loss of quality, and to reuse existing developments and achievements.

V. COMMUNICATION AND INFORMATION TRANSFER MODEL

In order to ensure mutual understanding between the education and IT professionals, special importance has harmonizing terminology, scientific models and conducting visual structural analysis at the junction of the exact sciences and the humanities.

An example of this approach can be the communication and information transfer model. With one side it shows processes in the data-processing and communication systems, and, on the other hand it is a model of communication in the system "teacher - student", "the speaker - listener", and as a simple model of interpersonal communication, including nonverbal components (Fig. 8).

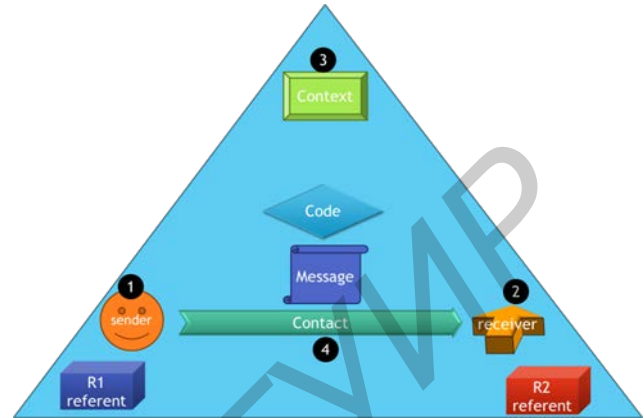

Fig. 8. Communication and information transfer model.

This model can serve as a bridge for implementation into new generation of LMS new tools to provide not only the structuring and transfer knowledge from a teacher to students, but also the quantitative and qualitative analysis student's levels of skills and competencies, and the parameters of its real progress along the learning curve.

This is especially important in the field of training and retraining of adults. As was shown in the works of A. Bandura [4], learning occurs in the interaction between the environment, human behavior and properties of his personality. At the same time the influence of previous experience leads to the fact that the learning curve instead usual logarithmic growth becomes distorted with several minimum points, so-called "barriers to overcome."

The use of modern IT technologies in conjunction with the use of effective models for acquiring skills allows to reduce or even completely eliminate the impact of these barriers and thus accelerate training and enhance their success. Modern system analysis tools and visual modeling, that proposed in this study will help to ensure this integration. They can effectively align the ontology in the domain field in terms of very different sectors of human activity, each with its own terminology, methodology and established paradigm.

VI. LINGUISTIC MODELS

The most important area of application visualization tools is linguistics and psycholinguistics.

By virtue of the fact that the description of any phenomenon, experiments or observations superimposed structural and semantic constraints and features of the language that provide this description, many scientific theories more or less susceptible to such influence. A visual representation of the structure and strict formalization of terminology will significantly reduce this impact.

This is most evident in the humanities fields of knowledge

that use to describe the subject of the study not the formal language of mathematical or logical analysis, but the words of ordinary language. It gives them specific values within a particular scientific paradigm and terminology.

In 1930 K. Gödel [10] has proved the incompleteness theorem to any formal mathematical system. However, these findings have not yet been adequately implemented in the construction of formal systems in other branches of knowledge, which not developed strictly formal sign system and using natural languages as a tool for the analysis.

Gödel's second incompleteness theorem also implies that the consistency of a formal theory can not be proved by means of this theory. In other words, the set can be a subset of itself, the system model can not be a part of the same system, and the object of research should not simultaneously be a tool of this study to avoid inconsistency and logical contradiction.

Therefore, the imposition of tools of analysis of linguistic phenomena beyond the system under study, ie, natural language, was a very promising way of research and produced very interesting results [11]. Development of Visual Meta-language and the use of the tools of mathematical, logical, and structural and visual analysis have created a new trend in language research, study of mental processes based on it, and developing new methods and ways of learning and languages acquisition.

This is especially true in today's globalized world with increased mobility of people, a huge number of international and cross-cultural communication and relationships, and grew out of the problems of integration in the different culture of immigrants, refugees, and their training and education.

Features of human thinking at the elementary level prevent the rapid integration in the new culture. Ordinary people are not able to keep track of their abstraction and not trained in the scientific way of thinking, so they tend to take over the properties of the surrounding reality, the properties of language to describe this reality.

This leads to the fact that in foreign language teaching the adults perceive a different language, a different grammar as a violation of the laws of nature and it is a totally inadequate structure to the world around them. This causes a strong internal opposition, emotional barriers, and cognitive dissonance.

Therefore, the provision of non-verbal tools for teaching foreign languages, new ways of working and new social interaction and communication is a very promising direction and opens up prospects for the development of effective ways to resolve these problems.

The proposed approach makes it possible to separate the structure of knowledge from the words of the language, move the meanings into the intermediate sign system in the form of the Visual Models. And then, without effort and psychological barriers to say the same in the target language, using as a basic patterns of speech not verbal rules, but visual structure, as shown in Fig. 6.

We have the full set of visual models for the major structures of the English language, and the pre-sets for the Russian and French languages.

The practical application of these models has shown interesting results that demonstrating the promise of this approach and its high potential.

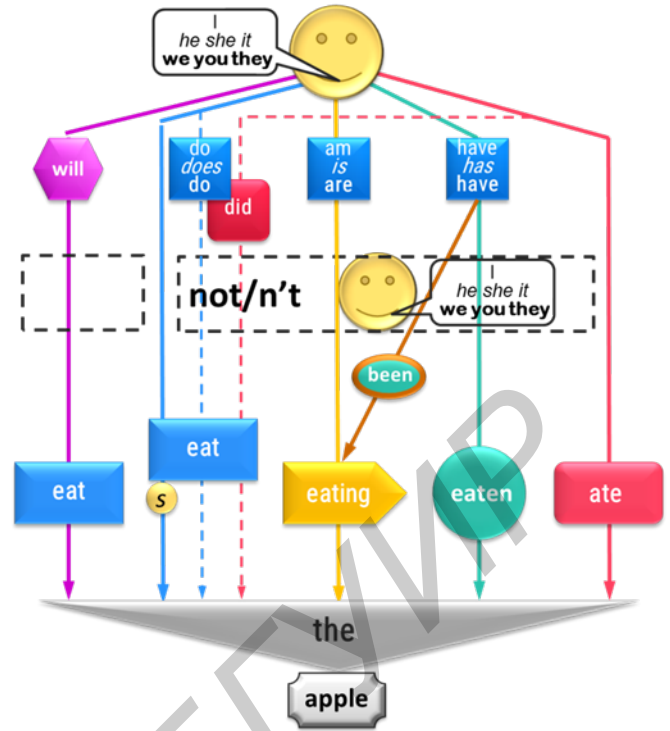

Fig. 9. English sentence model.

VII. VISUAL APPROACH AND LEARNING PROCESS MANAGEMENT

XXI century has put new challenges to the science and society in the field of education, training and transferring of accumulated scientific knowledge, technology, and cultural traditions. Old forms, that emerged many years and even centuries ago, in different economic, political and social conditions, today do not correspond to the current civilization level. A new ones, that would integrate the achievements of scientific and technological revolution and computer information technology, still can't constructively combine existing technical capacity with the developments in the humanities field (linguistics, pedagogy, methodology, psychology and psycholinguistics), due to completely different language to describe the subject areas, used tools and methods, the complexity of the organization and coordination of complex interdisciplinary projects.

The Visual Meta-language and Systems Analysis tools could be an integrating framework for the harmonization of terminology, methods, procedures and structures, as a link between theory and practice, IT and humanities field, science and social processes.

The authors recommend a conceptual solution in the form of the training system that allows to manage the process of formation of language and work skills of adults.

This system combines:

- the methodical principles, grounded in the works of P. Galperin and A. Bandura;
- the Visual Models, that creating a synergetic effect, both in the initial phase of mastering a foreign language, and at the stage of "barrier to overcome";
- the use of the achievements of the IT industry as a tool for ensuring the implementation of learning objectives with

continuous monitoring of the current status and receiving the guaranteed result of training in a finite number of steps.

This training system has the properties:

- the unity of the main goal of learning outcomes for all its elements;
- high stability of the entire system and the independent value of each element;
- correlation between the elements of the system, providing positive feedback in the process of formation of professional and language skills;
- properties of continuous assessment of the student's level of competence that allows the formation of logarithmic learning curve and compensates for background learning curve degradation towards an expected loss of competence;
- the ability to evaluate and compare the results of a similar educational systems and technologies as well as their individual components;
- platform-independent of any operating systems and programming languages, and invariant to the native language of the student and to the learning languages.

VIII. CONCLUSION

Recently there has been growing interest in the visualization and visual thinking.

Graphical user interfaces have become ubiquitous, visual and video content is the largest portion of the Internet traffic. Visualization of scientific data, creative ideas and business plans has long been a common practice.

But in the fields of science and education the role of the visual representation is still wrongly underestimated.

Although in this field has made considerable progress. In some countries, the development of the visual thinking is supported at the national level and the corresponding subject (MindMaps and so on) are imposed in schools.

But in most cases, the visual aids reduced to a simple demonstration of pictures and illustrations.

In our opinion, the visual approach may be used to study a very abstract theories and systems. It can help to find the new characteristics and patterns that have not been previously observed.

An attempt was made in this study to analyze some known scientific theories with the visual approach.

The analysis showed the presence of similar structures at the levels of description of physical processes, mental processes, social processes and the structure of language. This confirmed the findings of A. Korzybski that "... the structure which a language exhibits, and impresses upon us unconsciously, is automatically projected upon the world around us".

The observed regularities and patterns allowed to develop a visual model to demonstrate the structure of the language and its connection with the stage of development of the process and event in reality.

The use of such models for learning in the experimental groups showed an interesting results and a great perspective.

These models offer the prospect of creating effective computer applications in the field of language learning and other practical skills. They can increase the efficiency of the

educational process and reduce its costs.

REFERENCES

- [1] Science and Sanity: "An Introduction to Non-Aristotelian Systems and General Semantics", Alfred Korzybski, Preface by Robert P. Pula, Institute of General Semantics, 1994, 5th edition, ISBN 0-937298-01-8.3.
- [2] "Learning a New Skill is Easier Said than Done". Gordon Training International. <http://www.gordontraining.com/free-workplace-articles/learning-a-new-skill-is-easier-said-than-done/>
- [3] C. G. Jung, "Psychologische Typologie", Süddeutsche Monatshefte.— 1936. — Vol. XXXIII, № 5. — S. 264—272.
- [4] Bandura, A., & Walters, R. H. (1963). "Social learning and personality development". New York: Holt, Rinehart, & Winston.
- [5] P. Y. Galperin, "Psychology of thinking and teaching about the gradual formation of mental actions", Research in the thinking of Soviet psychology. Moscow, 1966.
- [6] Gardner, Howard (1983), "Frames of Mind: The Theory of Multiple Intelligences", Basic Books, ISBN 0133306143.
- [7] Anderson, Lorin W.; Krathwohl, David R., eds. (2001). "A taxonomy for learning, teaching, and assessing: A revision of Bloom's taxonomy of educational objectives". Allyn and Bacon. ISBN 978-0-8013-1903-7.
- [8] A. N. Leontiev. "Activities. Consciousness. Personality". Moscow, 1975.
- [9] Ozgun Demirag, Andy Johnson, Dima Nazzal, Yen-Tai Wan. "Integrated Definition (IDEF) Modeling Techniques". URL: http://www2.isye.gatech.edu/~lfm/8851...DEF_V4.ppt (date of access: 03.02.2004).
- [10] Kurt Godel (1931). "Über formal unentscheidbare Sätze der Principia Mathematica und verwandter Systeme, I" [On formally undecidable propositions of Principia Mathematica and related systems I]. Monatshefte für Mathematik und Physik. 38: 173–198.
- [11] A. K. Dadykin and V. A. Dibrova. "Generalized visual model of the structure of the educational process", *Modern trends in secondary adult education*, presented at the III International Scientific Method. Conf., Minsk, NIHE, 21 Oct 2016, vol. 1, pp. 62–67.

Alex K. Dadykin was born in Minsk December 8, 1957 year. Master degree, Phd in Automated Control Systems from Minsk High Engineering Military School of anti-aircraft missile defense graduated with honors, in 1980 and 1989 respectively. In 1991, he was awarded the degree of Candidate of Technical Sciences (Soviet Union), and in 1999 was awarded the academic title of Associate Professor on "Informatics, control and computer engineering" (Republic of Belarus).



From 2001 to 2009, he served as Scientific Secretary of the Council for the defence of dissertations at the Military Academy of the Republic of Belarus. Currently, he is a Chairman of the scientific meeting of the International Institute of Distance Education and an associate professor of the Department of Information Systems and Technology at the Belarusian National Technical University. He is the developer of four of the State educational standards for higher education for practice-oriented master's degree. His current research interests include mobile robotic systems and learning management systems.

Dr. Dadykin in 2009 was elected Professor of the Academy of Military Sciences of the Russian Federation. He is the author of more than forty educational-methodical and scientific works, has five inventor's certificate. He is the Senior Member of IEDRC. His main areas of research are in the field of discrete systems with fixed and random structure and system analysis.

Vitaly A. Dibrova was born in Poltava reg., Ukraine, May 26, 1963 year. Education: Kiev Polytechnic Institute, Ukraine, faculty of radio engineering, 1980-1986. Field of study: radio engineering



In 1986-1988 he served as an officer in Soviet Air Force. Since 1989 he worked as an engineer in the Science and Production Association "Karat". After collapse of the Soviet Union he worked in different fields of business.

In 2007 he launched the internet startup "Filolingvia" where he has been a CEO. For developing this project he was

involved in independent scientific research in different field of science. He is the author of four scientific publications, and has two inventor's certificate.

Imad H. Tahini was born in Aita el chaab, Lebanon, March 10, 1981 year. Education: From 1999 to 2006 he got a teaching diploma in applied mathematics option: computer science from Lebanese University faculty of science .From 2011 to 2012 he got a master degree in



computer science and communication from Arts, Sciences And Technology University in Lebanon. Since 2016 he is a Phd student at Belarusian National Technical University.

From 2006 to 2017 he worked as programmer, software development team leader and data analyst in HEC, HHC and Servo-pro Companies. he interested in developing business software and design for database methodology and he has a business knowledge in accounting and finance.

His current research in learning management system.

Библиотека БГУИР