

Cooperative Unmanned Air and Ground Vehicles for Landmine Detection

Moustafa M. Kurdi

Belarusian National Technical University, Minsk, Belarus
Email: mostafa.alkirdi@aut.edu

Aliaksei K. Dadykin, Imad A. Elzein and Ali K. Ibrahim

Belarusian National Technical University, Minsk, Belarus
Email: alex_05_07@rambler.ru , imad.zein@liu.edu.lb , alik.ibrahim2015@gmail.com

Abstract — over the last few years, cooperative autonomous systems have become a popular solution for crucial tasks such as landmine detection and removal that are otherwise performed by human operators. The unmanned aerial vehicle used in this research is multi-functional quadcopter with infrared camera and ground penetrating radar (GPR). The aerial vehicle detects the landmines using infrared camera and GPR; maps a pin in digital map for future use by ground vehicle. The ground vehicle used in this research is Belarus132N mobile robot. It has the following onboard sensors: stereo pair camera, GPS, and image processing system. The ground vehicle will use the above sensors and the map provided by the quadcopter to traverse the region, and locate the mapped landmines. The base station consists of a laptop that provides a communication link between the aerial and ground vehicle systems and for saving information from any destruction. It also provides the landmine operator or supervisor with landmine information about detection and position. This proposed system will demonstrate how an air-ground vehicle system use to cooperatively detect, locate and traverse of landmines.

Index Terms— Quadcopter Mobile Robot Demining robots, Multi-functional Mobile robot, GPR, Thermography Image.

I. INTRODUCTION

One of the unsolved problems with which humanity entered the third millennium is the problem of "humanitarian demining". After the end of the Second World War, numerous military conflicts continued to arise in all regions of the world, generated by national liberation and civil wars, international and inter-national confrontations. Official data of the United Nations show that in all regions of the world, there are about 110 million mines in the territories of 64 countries and about 100 million of them are in warehouses in readiness for immediate use.

According to the International Red Cross, around 800 people die on a monthly basis, most of them civilians; since 1975, over a million people have been killed or injured on mines. There are two types of landmines: anti-tank, and anti-personnel.

A reliable search for anti-personnel mines is the main task in the problem of humanitarian demining. Antipersonnel mines hit the enemy's living force with a shock wave (high-explosive mines) or mines that have flown out of the hull in advance in the form of pellets,

cylinders, arrows, or fragments formed by crushing the shell (fragmentation mines) [1].

Anti-vehicle mines are intended for mining of roads and railways, aerodromes. The charge of a mine can be calculated not only for the destruction of vehicles, but also for the destruction of the road.

Ground Penetrating Radar (GPR) is an electromagnetic device, which is one of the technologies that has been extensively researched as a means of improving the efficiency of mine operations (detection and removal). In addition to the geological and civil engineering applications, GPR uses for both civilian and military applications of landmine detection.

A wide range of thermal imaging holds vast areas or divisions of emergency must be secured in order to detect or to characterize the thermal purpose, such as people, animals and objects. As a result, thermography has many advantages, such as:

- i. Visual picture as temperatures over a large area.
- ii. Catch moving objects in real-time manner.
- iii. Utilized to discover surrenders shafts, channels and other metal or plastic parts.
- iv. Utilized to distinguish objects and people in dim spots.

Thermography system of object detection is designed for temperatures from a given point in the thermal image and projects its location directly on the digital map, based on dynamic scales coordinates and colors set by the user that help mobile to freely navigate in unknown environment especially in bad weather conditions (smoke, fog coated region).

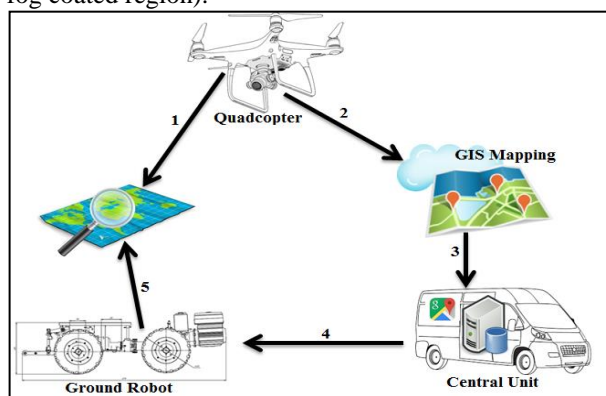

Figure 1. General Architecture of the Proposed System

We are designing and developing an intelligent system of unmanned air vehicle and unmanned ground vehicle named Quadcopter Mobile Robotic System (QMRS) [2], as shown in Fig.1, which performs several operations, as a movement in specified direction, detect landmine by quadcopter, project the landmine by GIS into digital map and navigate the projected landmine on digital map by mobile robot.

II. LANDMINE DETECTION

Landmines are unmistakable weapons, and they are unsafe and powerful, inexpensive, simple to produce and bury. Landmine consists of a ring mechanism, detonator that sets off the booster charge, and an explosive charge that constitutes the body of the mine and plastic, wood, ceramic or metal casing that contains the majority of the described elements. A landmine is a kind of independent-contained explosive device, which is set into the ground to constitute a mine area, and it is designed to devastate or harm, human and equipment [3].

Mines are produced in different shapes, sizes, explosive intensity and fusing. Both anti-personnel and anti-tank landmines come in different shapes and sizes, and can be covered by metal, plastic, wood, or pottery. They can be buried underground at various depths, placed on the surface, planted within buildings and on the streets, or covered by plant overgrowth.

Various techniques are used for the detection of landmines such as: 1) Optical; 2) Thermal Imaging; 3) Nuclear; 4) Metal Detector; 5) Electromagnetic; 6) Acoustic; 7) Mechanical Methods; 8) Biological; and 9) Latest Methods.

Depending on the tactics of use, mines have different weight and size dimensions and installation methods. Mines with the smallest dimensions (from 3 to 10 cm in height) are anti-personnel and are installed on the surface from aircraft (for example, helicopters) or manually. The remaining mines are laid in the ground to a depth of 5 to 30 cm from the top of the hull, depending on the mechanism of the fuse used [4].

The types considered can be reduced to one form - a cylinder with different ratios of height (h) and diameter (d). In Fig. 2 presents three generalized versions of the ratio diameter / height. The most common type of mine is shown in Fig. 2a.

Objects with a plastic body are the most difficult to detect due to the small difference in the electrical parameters of the mine material and the environment (Table I).

In addition, when detecting mines, the mine depth is of great importance. The propagation loss of the signal in the soil is high: for example, in loamy soil, the attenuation of the signal at a frequency of 1 GHz can reach 80 dB / m [5].

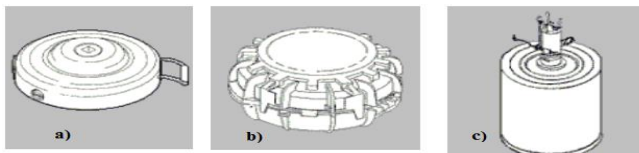

Figure 2. General Form of mines a) cylinder $d = 2.5h$; b) cylinder $d = h$; c) cylinder $d = 0.5h$

TABLE I. ELECTRICAL PARAMETERS OF SUBSTANCES

Substance	Avg values of permittivity	Substance
Plastic	3.3	<i>Housing material</i>
Wood	2.95	
TNT	2.7	<i>Explosive</i>
composition B	2.9	
RDX	3	
Dry sand	4	<i>Environment</i>
Wet sand	25	
Dry limestone	4	
Moist limestone	8	

III. PROPOSED SYSTEM

Quadcopter Mobile Robotic System (QMRS) is an efficient system for detection landmines. The system consists of ground robot Belarus-132N, ground-penetrating radar (GPR) and thermal camera attached to multi-functional quadcopter [6].

The procedure for landmine operations by using robot interactions is as follows (Fig.1):

1. Quadcopter takes off, moves over the region, photograph the area, searches and detects landmine by infrared camera and ground penetrating radar.
2. Quadcopter projects the landmine findings into Geographic Information System (GIS) Mapping.
3. Quadcopter transmits GIS images, collected data to base-station located near to the field of operation.
4. Central Unit Base Station uploads the GIS landmine findings into digital iCloud-google-map, and then it sends the updated digital map to the Ground Robot.
5. Ground Robot uses digital iCloud-google-map to move through the operational area and traverse the landmines.

A. Ground Robot Belarus 132N

Belarus-132N is a ground robot designed and manufactured by an international company from Belarus. It is a 4-wheeled robot with dimensions 120cm length, 120cm width, 180cm height, and 500kg weight.

It comprises of serial frame of tractor Belarus-132N and image processing system; control system; positioning and navigation; microcontroller; communication systems for sending and receiving data; attachments, such as arm as shown in Fig.3.

Ground Robot Belarus-132N has four-types of motion control: i) Driving forward on the route; ii) Turning Left or Right; iii) Return with rotation; and iv) Driving backward (blind movement).

Our ground-based robot designed to determine their location and their identification, because when using the equipment of the quadcopter of the robotic complex there are a lot of noise and false objects similar to mines. The

use of ground-air robot will provide the necessary 100% mine detection.

1) GPS of Ground Robot

The navigation system identified with GPS gives the following tasks: estimate the position of robot; calculate the optimal navigated route, and deliver to the central base station; receive data/commands from the remote control/central base station; decode commands from the remote sensors and to initiate these programs.

2) Image Processing System

The image processing system plays out the following tasks:

- i. Accepting flow of data from stereo-pair cameras and hard-disk storage;
- ii. Compression of video-data with a particular channel and delivery to an external PC operator;
- iii. Getting a pointer to catch an object / item, catching guideline and instruction, the seizure of the specified and selected object to the issuance of the catch flag to an external PC operator;
- iv. Calculating of distance to the selected object with the displaying output to external PC operator;
- v. Viewing the captured and selected object.

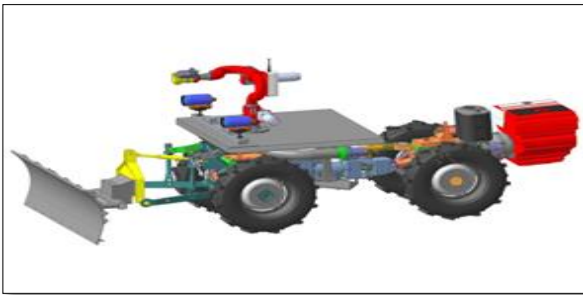

Figure 3. General Scheme of mobile Belarus-132N

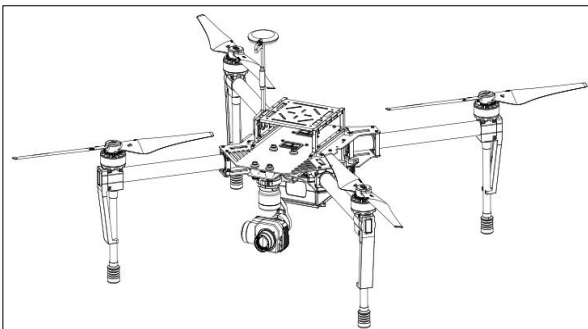

Figure 4. General Scheme of multi-functional quadcopter

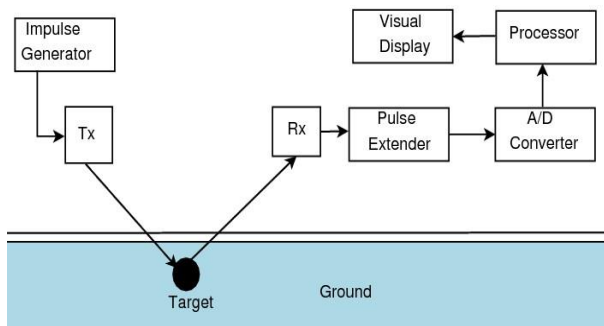

Figure 5. GPR technologies for landmine detection

B. Multi-functional Quadcopter

A quadcopter or Unmanned Aerial Vehicle is a 4-rotor helicopter that use these four rotors in departing and landing. Quadcopter is a standout amongst the best vertical take-off and landing vehicle with autonomous flight control and stable hovering capabilities (Fig.4).

The components of Quadcopter are frame *F450*, *EMAP Simon 30A* Electronic Speed Controller, *EMAX-MT-2213* motor, Flight controller *KK v2.0* board, 2.4GHz receiver, transmitter, *MPU9255* – gyroscope – accelerometer – compass, single-board *Raspberry Zero W*, *Wi-Fi* adapter, universal *GPIO I/O* ports, Saitek *X52* to ensure full-duplex communication, and 3-cell 2200mAh 25C LiPo Battery.

1) Ground Penetrating Radar (GPR)

In Fig.5, a short pulse generator is connected to a transmitting (TX) antenna. The pulse duration is usually in range of a nanosecond or sub-nanosecond [7]. When a pulse is radiated through the TX antenna, the analog to digital converter (ADC) at the receiver is triggered. The time duration that the pulse needs to travel to the target and back to receiving (RX) antenna has to be sampled with high speed [8].

2) Zenmuse XT FLIR Thermal Imaging Camera

Using *Zenmuse XT FLIR* thermal imaging for small drones brings new capabilities to dozens of applications like search and rescue, the inspection of power lines, cell towers, bridges, substations, and buildings, firefighting, precision agriculture, and natural resource and wildlife protection.

It has multiple lens options (640×512 or 336×256 resolutions) to ensure the right combination of situational awareness, magnification, spot size, and area coverage to suit the mission requirements.

Thermography system consists of several parts: i) the projection on the digital map: link between the system of heat detection and digital maps; ii) Dynamic display by setting the initial coordinates of the image; iii) Control and monitoring.

The Visualization of the flight-quadcopter-state and 3-dimensional representation of space is represented by Fig.6. Image processing of the quadcopter using 3D-model created by the flight route of the quadcopter based on the information from infrared camera. To create a 3D-map representation image processing system requires hundreds of overlapping images, as shown in Fig.7.

3) Coverage Path Planning

Coverage path planning is the operation of finding efficiently a path that covers all the points of a specific area.

The quadcopter will fly over the area [9] to be covered executing a back and forth motion in rows perpendicular to a given sweep direction, as shown in Fig.8. While following the rows, the UAV is leveled, but at the end of the row, it makes a curve outside the area to return to the next row. Knowing that, the number of turns directly related to the time of coverage of a given region.

C. Central Unit Station

The central unit Station is responsible of receiving information (detection and data collection) from the

quadcopter, and a moving ground robot unit for mine traversing and transferring collecting data to the central unit.

Quadcopter and Ground Robot will communicate wirelessly with the central unit. Especially from the quadcopter, this will insure the receiving of all necessary data even in case of losing the unit. Information transferred from quadcopter is typically the location of each detected suspected object and images from that location.

To guarantee the recipient of all data from the operated field with no losses, a balance between the safety of the central unit from any possible explosion and the quality of communication is the based-on factor to choose the location of the central unit for each area.

A web server application with a database server hosted on the central unit to do the following tasks:

- Receive data from quadcopter and to analyze it directly in the field.
- Upload the detected-mines information into digital map for future investigation in case of need.
- Send the updated digital map to mobile robot to locate the detected mines.
- Receive updated information from ground robot.

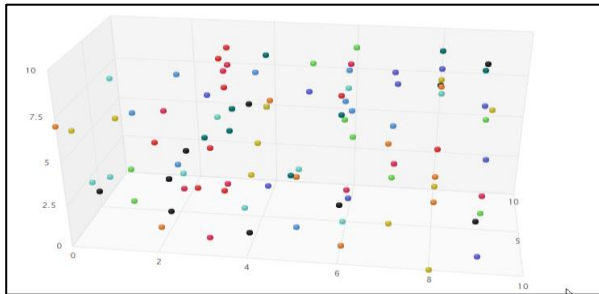

Figure 6. Visualization of the flight state and three-dimensional representation of space

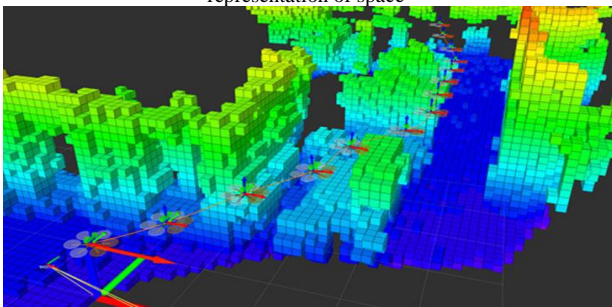

Figure 7. The flight route of the quadcopter based on the infrared camera data

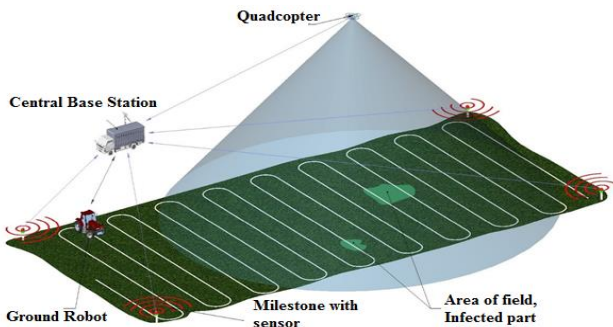

Figure 8. General Scheme of coverage path planning

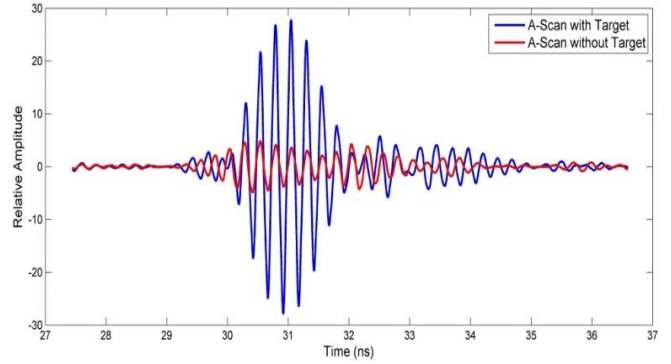

Figure 9. Example of a comparison between two A-scans, one taken over a metallic mine object and the other without mine object

D. Digital Updating Map

Each landmine, projected on a digital-iCloud-Google-map, has the following properties: i) Identifier – Unique number assigned to every new landmine as long as there is no decision on the deletion of the landmine; ii) Position and depth of landmine t in the ground (x_r, y_r, z_r); iii) Dimension of new landmine object; and iv) Landmine type (anti-personal or anti-tank).

The cloud environment existed for two purposes. Firstly to share information that the Quadcopter had collected with an external system (base station) running a Google Cloud Maps, thus allowing human observers field situational awareness. Secondly, this system allowed mission parameters to be decided upon and then sent to the ground robot. The human interface allowed users to control the air and ground robots as desired by changing the individual parameters, authorizing, or altogether canceling the missions.

IV. EXPERIMENTAL RESULTS

Given a transmitter and a receiver as shown in Fig.5, the efficient and simplest data acquisition method is to record a single scan of the subsurface, and consider the received signal. This received signal is termed an A-scan, and relates the signal amplitude with range. An example of two A-scans recorded using the Time Domain GPR are shown in Fig.9. Here the independent axis is time, which is related to the range, or in this case, target depth by the wave velocity ($v = d/t$), and the dependent axis is the amplitude of the received signals. The first A-scan (red graph) was recorded without anything-buried mines while the second A-scan (blue graph) was recorded above a mine target [10-12]. This comparison between A-scans, demonstrates how the presence of a target alters the received signal, and the direct communication that occurs between the antennas.

V. CONCLUSION AND FUTURE WORK

Detection process of these mines usually takes a lot of time and effort and hence, it is usually neglected to the last step of priority levels. The GPR and Thermal image detectors automatically detect landmine; quadcopter updates GIS map and transfer the information about mine object to a central unit that will be responsible of

investigating the received data; central base sends updated map to ground robot to start navigation.

GPR shows a promise, that is seems capable of accurately detect mines in various environments with few false alarms. GPR also suffers problems due to the presence of much clutter of components, that thermal image is used to reduce the clutter components in order to reduce the false alarm rates and increase probability of detection.

In the future, we will use new technology of detection of explosive objects on the ground and under the ground based on the operation of a mobile robotic complex using 3D-space representation. Moreover, the system is able to work in the absence of GPS and Wi-Fi only based on its own data received by the quadcopter sensors and displayed on the simulator and a pre-prepared digital map.

REFERENCES

- [1] B. Barkat, A. Zoubir, C. Brown, "Application of Time frequency Techniques for the detection of Anti-personal Landmines", Proceedings of the 10th IEEE Signal processing Workshop, pp 594-597, 2000.
- [2] M. Kurdi, A. Dadykin, I. Elzein, M. Tatur, "Efficient Navigation System of Mobile Robot With Thermography Image Processing System And Mapping of Quadcopter", 4th International Conference on Computer Science Computer Engineering and Education Technologies (CSCEET2017), Beirut – Lebanon, IEEE: pp. 23-28, ISBN: 978-1-5090-1908-3.
- [3] D. Daniels, "A review of GPR for landmine detection, Sensing and Imaging", An International Journal, Vol. 7, No. 3, September 2006.
- [4] A. Mayordomo, A. Yarovoy, "Optimal Background Subtraction in GPR for Humanitarian Demining", Proceedings of the 5th European Radar Conference, October, 2008.
- [5] S. Sule; K. Paulson, "A comparison of bistatic and multistatic handheld ground penetrating radar (GPR) antenna performance for landmine detection", 2017 IEEE Radar Conference (RadarConf), pp.1211-1215, doi:10.1109/RADAR.2017.7944389
- [6] M. Kurdi, A. Dadykin, I. Elzein, "Design and Development of Efficient Guidance System Using Multi-functional Robot with Quadcopter," International Journal of Electrical Energy, Vol. 5, No. 1, pp. 81-86, June 2017. doi: 10.18178/ijoee.5.1.81-86
- [7] L. Cirillo, C. Brown, A. Zoubir, "Polynomial Phase Signal Based detection of Buried Landmines Using Ground Penetrating Radar", Proceedings of the 11th IEEE Signal Processing Workshop, pp 166-169, 2001.
- [8] David J Daniels, "A review of GPR for landmine detection, Sensing and Imaging", An International Journal, Vol. 7, No. 3, September 2006.
- [9] L. Nam, , L. Huang, X. Li, and J. F. Xu, "An approach f or coverage path planning for UAVs", 2016 IEEE 14th International Workshop on Advanced Motion Control (AMC), 2016.
- [10] A. Zoubir, I. Chant, C. Brown, B. Barkat, C. Abeynayake, "Signal Processing Techniques for Landmine Detection Using Impulse Ground Penetrating Radar", IEEE Sensors journal, Vol. 2, No 1, Feb, 2001.
- [11] D. Šipoš, P. Planinšič, D. Gleich, "On drone ground penetrating radar for landmine detection", 1st International Conference on Landmine: Detection, Clearance and Legislations (LDCL2017), Faculty of Engineering - Lebanese University, Beirut – Lebanon, IEEE CRN 40735, ISBN: 978-1-5090-5822-8, April 26-28, 2017.
- [12] A. S. Venkatachalam, X. Xu, D. Huston, T. Xia, "Development of a New High Speed Dual-Channel Impulse Ground Penetrating Radar,"IEEE Journal Of Selected Topics In Applied Earth Observations And Remote Sensing, Vol. 7, No. 3, pp. 755-756, March 2014.

Moustafa M. Kurdi received the BE degree from Beirut Arab University in 2002, and the postgraduate degree from Lebanese International University at Lebanon, in 2010.



Currently, he is coordinator of faculty of applied sciences, American University of Technology (Lebanon). He has more than 10 years of academic teaching experience in the fields of computer, software and networking engineering.

Mr. Kurdi is member of IEEE. His current research interests include robotics, computer vision, intelligent mobile robots, navigation system, image watermarking, and design automation.

Aliaksei K. Dadykin received the military degree from Minsk Suvorov Military School, in 1975, and Master degree, Phd in Automated Control Systems from Minsk High Engineering Military School of anti-aircraft missile defense with honors, in 1980 and 1989 respectively.



Currently, he is a chair of the scientific meeting of the International Institute of Distance Education (MIDO) BNTU, the member of the Council on thesis defense at BNTU, and an associate professor of the Department of Information Systems and Technology National Technical University.

He is the author of 40 research works. He has five inventor's certificate. His current research interests include robotics, 4-wheel mobile robots, system analysis, management and information processing, and design automation.

Imad A. Elzein is an electronics and computer engineer who obtained his undergraduate and graduate level degrees in electronics and computer engineering from Wayne State University, Michigan, USA in 2004.



Currently, he is an Assistant Professor at the computer Science and Information Technology Department, School of Arts and Sciences, Lebanese International University (Lebanon).

Imad has more than 17 years of solid hands-on experience in the design, testing, and analysis of electronics, telecommunication, and networks engineering environments. His research of interests is in the fields of Renewable Energy, Network Design, and Robotics.

Ali K. Ibrahim received Diploma in Engineering - Intelligent Systems in 2017, and Master in automation and control of technological processes and production from Belarus National Technical University in 2018.



His current research interests include automation, Intelligent Systems, robotics, and control of technological processes.